



GAI-TRONICS®  
A HUBBELL COMPANY

# SP2 Handset/Speaker Amplifier Station

## TABLE OF CONTENTS

<i>Confidentiality Notice</i> .....	1
<i>General Information</i> .....	1
<b>Product Overview</b> .....	1
<b>Features</b> .....	2
<b>Options</b> .....	2
<i>Installation</i> .....	3
<b>Important Safety Instructions</b> .....	3
<b>Enclosure Mounting and Cable Entries</b> .....	4
<b>Open the Station</b> .....	5
<b>Field Wiring and Configuration</b> .....	5
Station Ground.....	5
Termination PCBA .....	6
Main PCBA.....	11
<i>Settings and Adjustments</i> .....	13
<b>Open the Station</b> .....	13
<b>Main PCBA Configuration</b> .....	13
Write Protect (EEPROM) Jumper.....	13
WDOG Enable (Watchdog) Jumper .....	13
Boot Enable Jumper .....	13
Reset Switch.....	14
Speaker and 600-ohm Audio Output Volume.....	14
Receiver Volume .....	15
Group and Station Number Selector Switches.....	15
<b>Main PCBA Indicators</b> .....	15
Power LED.....	15
Heartbeat LED .....	15
Ethernet Connection LEDs .....	15
Five Configurable LEDs .....	16
<b>Front Cover Installation</b> .....	16
<i>Programming</i> .....	16
<i>Operation</i> .....	16
<b>Standard Handset Paging</b> .....	16
<b>Party Line Communication</b> .....	17
<b>All-Call Button Use</b> .....	17

---

<b>Alternate-Page Destination Switch Use</b> .....	<b>18</b>
<b>Headset Use</b> .....	<b>18</b>
<b><i>Maintenance</i></b> .....	<b><i>19</i></b>
<b>Troubleshooting</b> .....	<b>19</b>
<b>Service and Spare Parts</b> .....	<b>20</b>
<b><i>Reference Documentation</i></b> .....	<b><i>20</i></b>
<b><i>Specifications</i></b> .....	<b><i>20</i></b>
<b>Power</b> .....	<b>20</b>
<b>Ethernet</b> .....	<b>21</b>
<b>RTU</b> .....	<b>21</b>
<b>Audio</b> .....	<b>21</b>
<b>Mechanical</b> .....	<b>22</b>
<b>Environmental</b> .....	<b>22</b>
<b><i>Approvals</i></b> .....	<b><i>22</i></b>



**GAI-TRONICS®**  
A HUBBELL COMPANY

# SP2 Handset/Speaker Amplifier Station

## Confidentiality Notice

This manual is provided solely as an installation, operation, and maintenance guide and contains sensitive business and technical information that is confidential and proprietary to GAI-Tronics. GAI-Tronics retains all intellectual property and other rights in or to the information contained herein, and such information may only be used in connection with the operation of your GAI-Tronics product or system. This manual may not be disclosed in any form, in whole or in part, directly or indirectly, to any third party.

This product contains copyrighted computer programs stored in semiconductor memory. These programs are copyrighted by GAI-Tronics Corporation and may not be reproduced in any form without express written permission from GAI-Tronics.

## General Information

### Product Overview

The GAI-Tronics SP2 station is a modular industrial multicast VoIP (Voice over Internet Protocol) communication system. The standard handset/speaker amplifier SP2 configuration is an indoor, multi-party, handset/speaker amplifier station using ac power with RTU control. They are constructed of cold rolled steel with a gray or safety orange powder-coat finish. A number of options are available to add to or modify station capabilities (see the [Features](#) and [Options](#) sections below).

SP2 stations connect to an Ethernet network so the loss of a single station will not adversely affect the entire system. Each station requires a 100 Mbps link to a switch or router using category 5e or better Ethernet cable. Isolate SP2 network traffic from other network devices and properly configure network switches and routers for IGMP (Internet Group Management Protocol) snooping and multicast filtering to ensure the quality of SP2 audio. Maximum cable runs between SP2 stations and network switches are limited to 100 meters to comply with Ethernet standards.

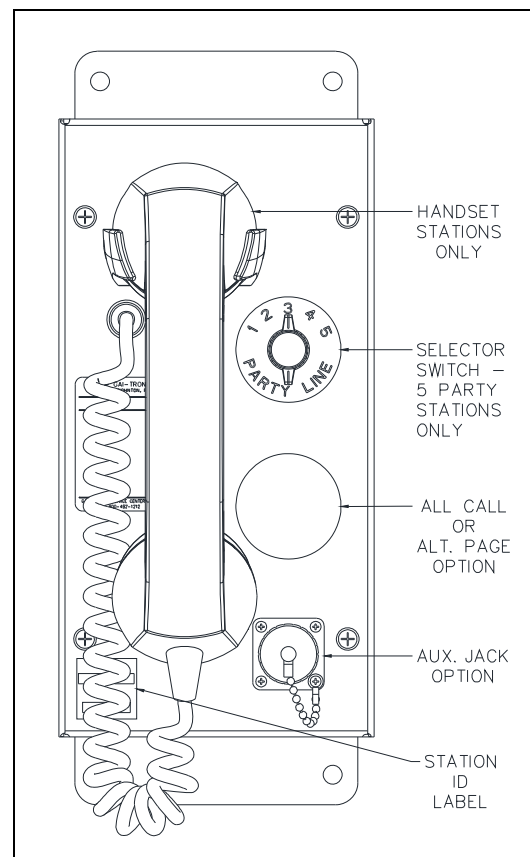

Figure 1. SP2 Station Front View

## Features

- flexible and highly configurable SMART technology featuring ALS (ambient level sensing), real time self-diagnostics, and available remote monitoring
- real-time operation providing instantaneous page and party line communication
- no SIP server or conference bridge requirement
- one-way live paging and alarm annunciation over system speakers
- distributed amplifier topology—loss of an individual amplifier will not adversely affect the remaining system
- mutual provisioning mode allows easy system deployment
- high efficiency (>80%) Class D paging amplifier provides up to 30 watts of speaker output at 8 ohms
- five configurable multicast channels for full-duplex conference communication with party line selector switch
- eight configurable multicast channels for receiving page announcements
- one isolated output for beacon activation
- two isolated inputs (one isolated input with optional 70V/100V termination PCBA)
- 600-ohm audio I/O with control
- configurable priority scheme allows urgent/emergency pages to override less important pages
- configuration stored in non-volatile memory
- field adjustable volume control for handset earpiece, headset earpiece, and speaker amplifier
- configurable local and nearby speaker mutual muting to prevent acoustic feedback of live pages
- configurable pre-announcement tone
- off-hook and page switch timeout functionality
- configurable virtual zoning ability
- USB interface for field or bench configuration
- universal ac power supply
- durable, high-visibility safety orange powder coat finish



## Options (All SP2 options are factory installed)



- 70/100V constant voltage termination board with 24-watt monitored output
- 24 V dc power supply
- speaker amplifier only (no handset)
- headset with page pressbar for loud environments
- five configurable multicast channels for alternate page destinations with page line selector
- All-Call push button for secondary page destination
- PVC or Hytre<sup>®</sup> handset cords in 6-, 15-, or 25-foot lengths
- conformal coating for PCBA
- gray powder-coat finish



# Installation

## Important Safety Instructions

- **Read, follow, and retain instructions**—Read and follow all safety and operating instructions before installing or operating the unit. Retain instructions for future reference.
- **Heed warnings**—Adhere to all warnings on the unit and in the operating instructions.
- **Attachments**—Do not use attachments not recommended by the product manufacturer, as they may cause hazards.
- **Servicing**—Do not attempt to service this unit. Opening or removing covers may expose dangerous voltage or other hazards. Refer all servicing to qualified service personnel.

 **ATTENTION**  —Install equipment without modification and according to all applicable local, national, and international electrical codes. North America—Consult the National Electrical Code (NFPA 70), Canadian Standards Association (CSA 22.1), and local codes for specific requirements regarding your installation. Install Class 2 circuit wiring in accordance with the NEC.

 **WARNING**  —Do not install this equipment in areas other than those indicated in the Approvals section of this manual. Such installation may cause a safety hazard and consequent injury or property damage.

 **WARNING**  —***In 24 V dc systems:*** Do **NOT** operate this equipment from a battery charger with the batteries disconnected. Most 24 V dc battery chargers have an unloaded output of 35 to 45 volts that can quickly damage equipment designed for 24 volts nominal. Do not allow the maximum battery voltage to exceed the maximum specified input voltage.

 **WARNING**  —**Do not disconnect equipment while energized.**  
**Ensure proper grounding to protective earthing.**

Only trained, qualified, and competent personnel must install these enclosures. Installation must comply with state and national regulations, as well as safety practices for this type of equipment.

## Enclosure Mounting and Cable Entries

The mounting location must be flat and provide proper clearance, rigidity, and strength to support the enclosure and all contained devices.

1. Mount the enclosure using the four 0.312-inch (8 mm) diameter holes located on the mounting flanges with 1/4-inch (M6) hardware (see Figure 2).
  - The suggested mounting height for all station enclosures is 48 inches (1219 mm) to the center of the bottom mounting holes of the enclosure.
  - SP2 stations are not supplied with conduit or cable openings.
2. Remove the front panel (see the The station is suitable for bottom and/or top entry.
  - using 70-volt/100-volt line audio requires bottom entry.
  - *Recommended:* Bottom entry prevents condensation that may form in the conduit from dripping onto the termination PCBA.
  - The minimum material (spacing) between entry holes is 1/2 inch (13 mm).

**NOTE:** Do not use top entry with the 70V/100V termination PCBA.

3. Open the Station section).
4. Drill or punch entry openings in the rear section of the enclosure (see Figure 2).
  - The station is suitable for bottom and/or top entry.
  - using 70-volt/100-volt line audio requires bottom entry.
  - *Recommended:* Bottom entry prevents condensation that may form in the conduit from dripping onto the termination PCBA.
  - The minimum material (spacing) between entry holes is 1/2 inch (13 mm).

**NOTE:** Do not use top entry with the 70V/100V termination PCBA.

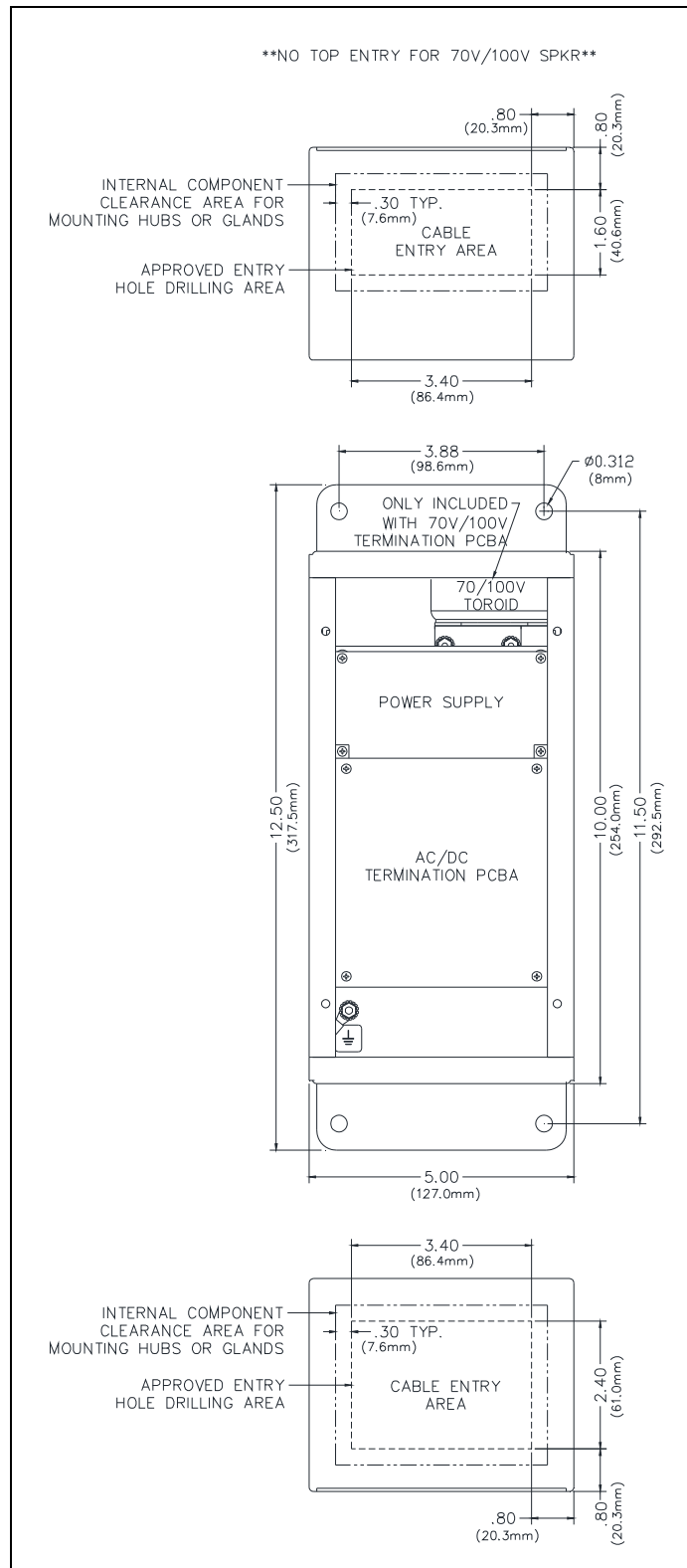

Figure 2. Suggested Wire Entry Locations

## Open the Station

Complete the following steps to open the station:

1. Remove the four screws from the front panel and turn it to the left to expose the interior surfaces.
2. Keep the wiring and ribbon cables connected.
3. Mount the front panel to the holes on the left side of the rear enclosure using two of the screws just removed.

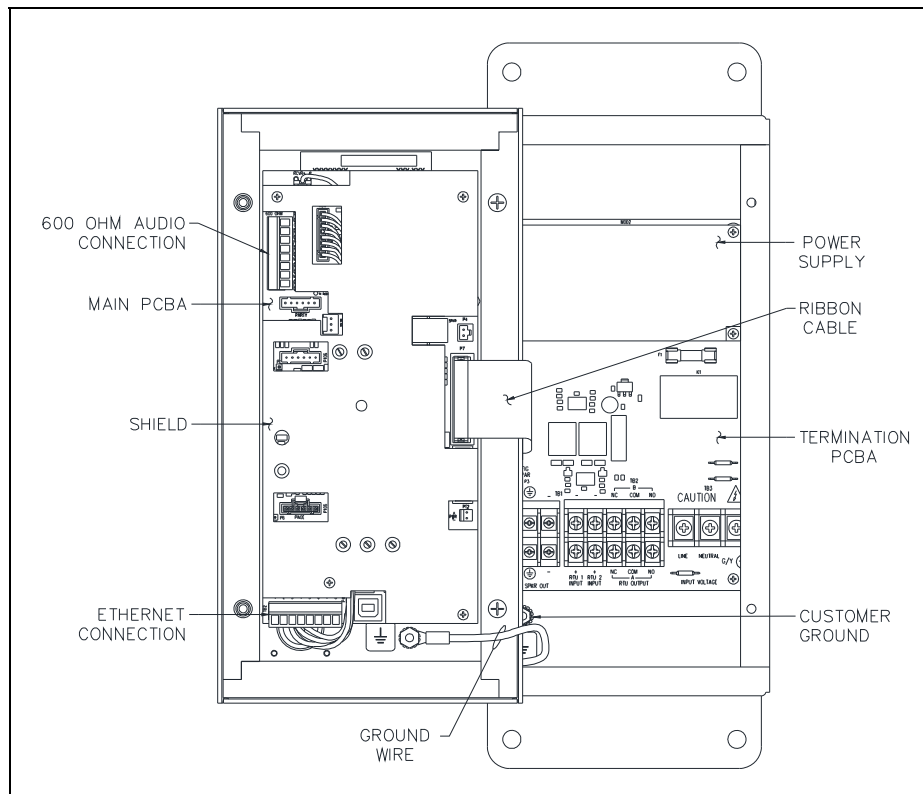

Figure 3. SP2 Station—Interior View

## Field Wiring and Configuration

The SP2 handset/speaker amplifier station provides terminal blocks on the termination PCBA, located in the rear of the enclosure, for field wiring the power, speaker, and RTU connections. The main PCBA, mounted to the back of the front panel, provides pluggable terminal blocks for the Ethernet and 600-ohm audio connections.

**NOTE:** Consult the National Electrical Code (NFPA 70), Canadian Standards Association (CSA 22.1), and local codes for the specific requirements regarding your installation. Install all equipment without modification and according to the local and national codes. Install Class 2 circuit wiring in accordance with the NEC.

### Station Ground

Connect the station enclosure to earth ground:

1. Install a #6 ring lug on the ground conductor.
2. Secure it to the ground terminal located in the lower left corner at the back of the rear enclosure (see [Figure 3](#)).

## Termination PCBA

Install all connections as indicated in the following sections:

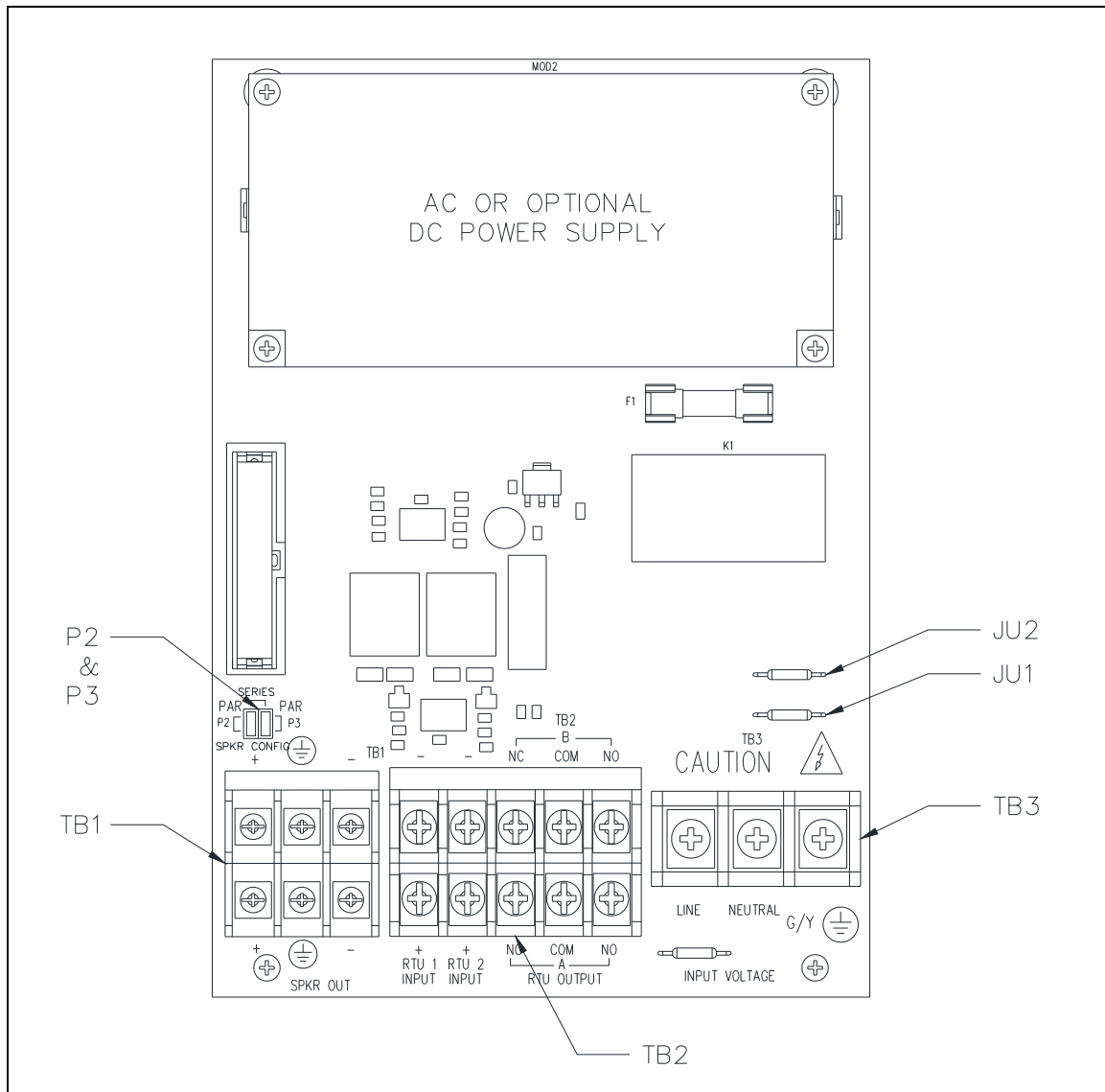

Figure 4. SP2 Standard Termination PCBA  
(Optional 70V/100V Termination PCBA Similar)

### Direct Speaker Connection and Jumper Settings

Terminal block TB1 provides termination for the station's 8 or 16-ohm remote speaker(s).

1. Pull the speaker cable(s) into the enclosure.
2. Install spade lugs on the wires.
3. Connect the speaker wires to terminal block TB1 (see [Table 1](#)).
4. Torque the terminal block screws to 8–10 in·lb (0.90–1.13 N·m).
5. Configure the speaker jumpers; P2 and P3, for the appropriate impedance for use with 8-ohm or 16-ohm speakers (see [Figure 4](#) and [Figure 5](#)).

A redundant set of terminals enables connection of a second speaker branch connected in series or parallel with the primary speaker.



Table 1. Direct Speaker Connections—TB1

Pin	Label	Description
TB1-1	+	Parallel/SPEAKER A Series—Output
TB1-2	⊥	Earth Reference
TB1-3	-	Parallel/SPEAKER A Series—Output
TB1-4	+	Parallel/SPEAKER B Series—Output
TB1-5	⊥	Earth Reference
TB1-6	-	Parallel/SPEAKER B Series—Output

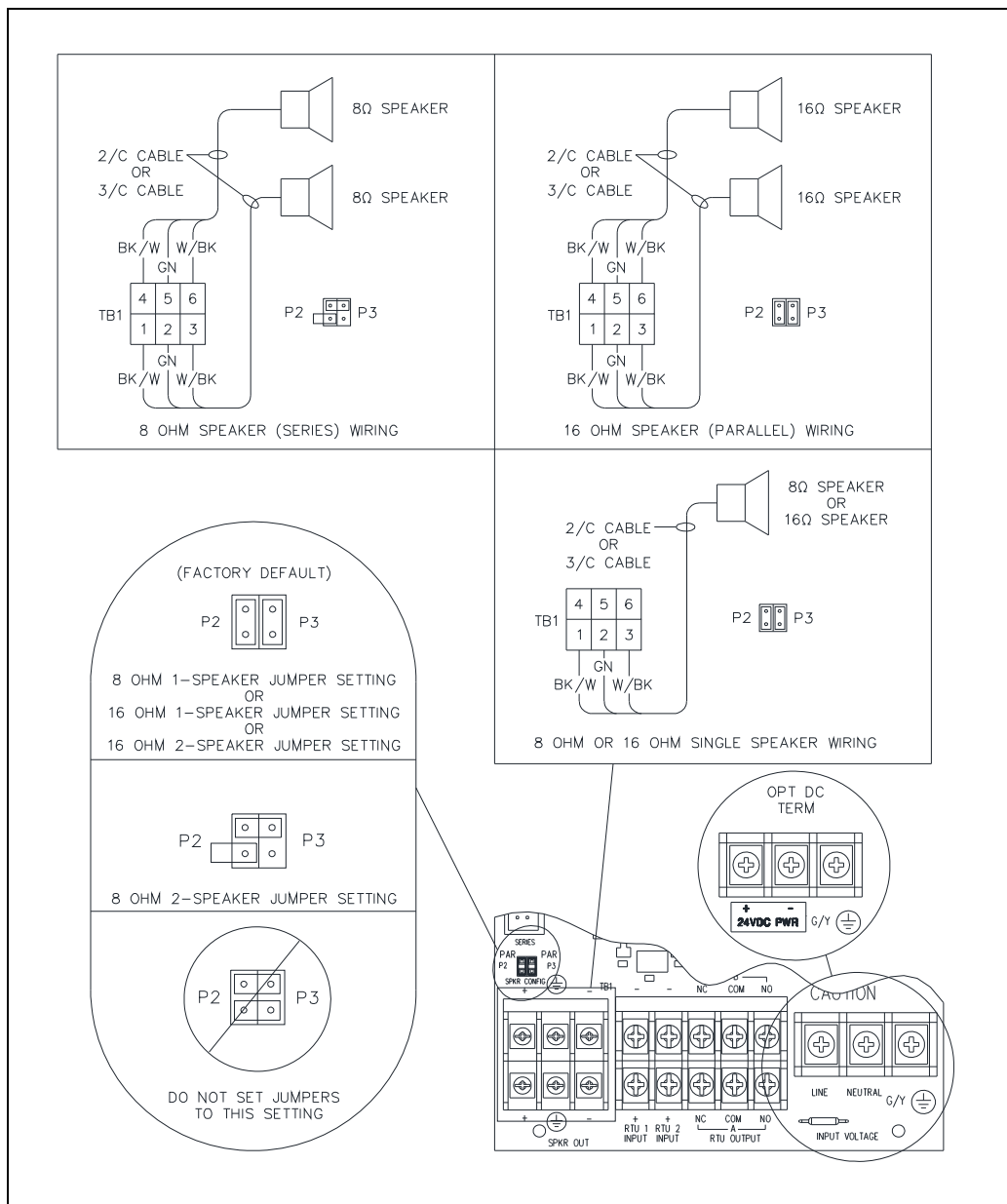

Figure 5. 8/16-ohm Speaker Impedance Configuration and AC/DC Termination at TB3

**70-V/100-V Termination Board Option—Speaker Connections with Monitoring**

The optional 70-volt/100-volt speaker line-monitoring PCBA replaces the standard termination board and enables connection of 70-volt and/or 100-volt speakers to the SP2 station. Terminal block TB1 provides termination for the station’s speaker loop(s). Wire all speakers in parallel. Monitor one speaker loop by terminating the return cable to the LINE SPRVN terminals at terminal block TB2 (see Figure 6 and Table 2).

1. Pull the 70-volt and/or 100-volt speaker cable(s) into the enclosure.
2. Install spade lugs on the wires.
3. Connect 100-volt speakers between the 100V and COM terminals on TB1. Connect 70-volt speakers between the 70V and COM terminals on TB1.

Two sets of terminals exist for the 70-volt and 100-volt speaker loops, providing termination for additional speaker loops.

**NOTE:** The station can only monitor one speaker loop.

4. For speaker line supervision, connect the speaker return wires to the LINE SPRVN + and – terminals at terminal block TB2 (see Table 4).
5. Move jumper P2 to pins 2–3 to enable ground fault monitoring.
6. Torque the terminal block screws to 8–10 in·lb (0.90–1.13 N·m).

**NOTE:** The combined wattage (tap settings) for all speakers must never exceed the amplifier power rating (24 W).

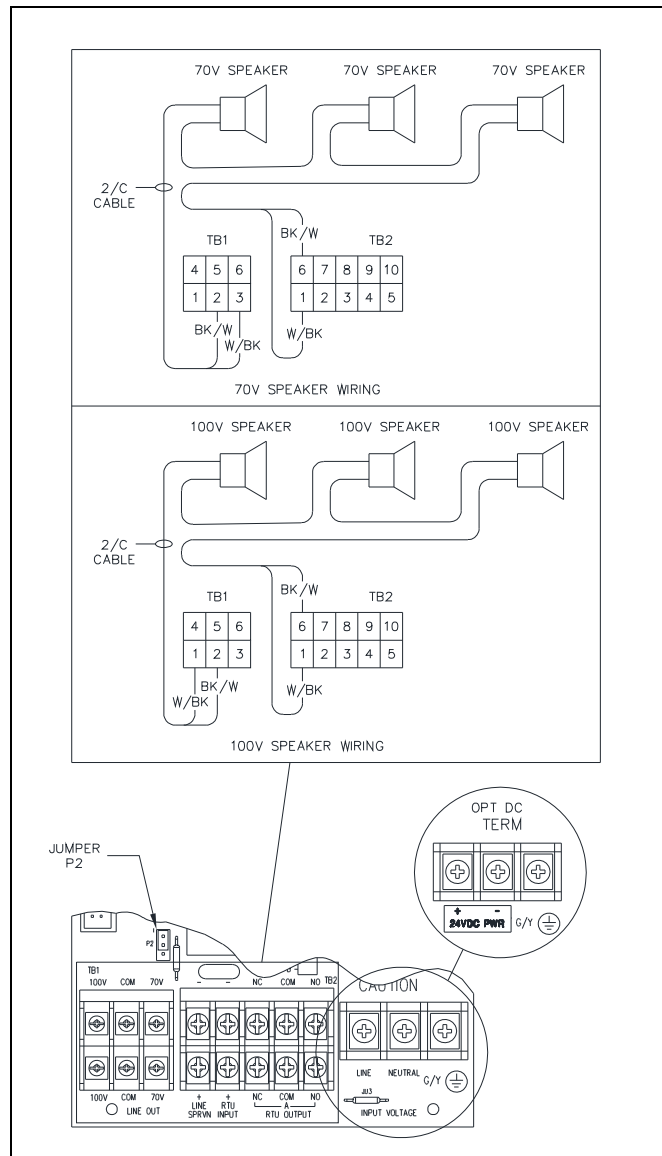

Figure 6. 70-V/100-V Termination PCBA

Table 2. 70 V/100 V Speaker Connections—TB1

Pin	Label	Description
TB1-1	100V	100 V Parallel Speakers—Output
TB1-2	COM	Common
TB1-3	70V	70 V Parallel Speakers—Output
TB1-4	100V	100 V Parallel Speakers—Output
TB1-5	COM	Common
TB1-6	70V	70 V Parallel Speakers—Output

**RTU Inputs**

The standard termination PCBA contains two auxiliary RTU inputs. The optional 70V/100V termination board provides speaker line monitoring and has just one auxiliary RTU input. These inputs are terminated at terminal block TB2 (see Figure 4).

1. Pull the RTU input cable(s) into the enclosure.
2. Install spade lugs on the wires.
3. Connect the RTU input wires to terminal block TB2 (see Table 3 or Table 4).
4. Torque the terminal block screws to 8–10 in·lb (0.90–1.13 N·m).
5. Install end-of-line resistors (see Figure 7) to enable RTU input-cable monitoring.

Table 3. Standard Termination Board  
RTU Input Termination—TB2

Pin	Label	Function
TB2-1	+ RTU 1 INPUT	RTU Input 1 +
TB2-2	-	RTU Input 1 -
TB2-3	+ RTU 2 INPUT	RTU Input 2 +
TB2-4	-	RTU Input 2 -

Table 4. 70V/100V Termination Board  
Speaker Line Monitoring and RTU Input  
Termination—TB2

Pin	Label	Function
TB2-1	+ LINE SPRVN	70 V/100 V Supervision +
TB2-2	-	70 V/100 V Supervision -
TB2-3	+ RTU INPUT	RTU Input +
TB2-4	-	RTU Input -

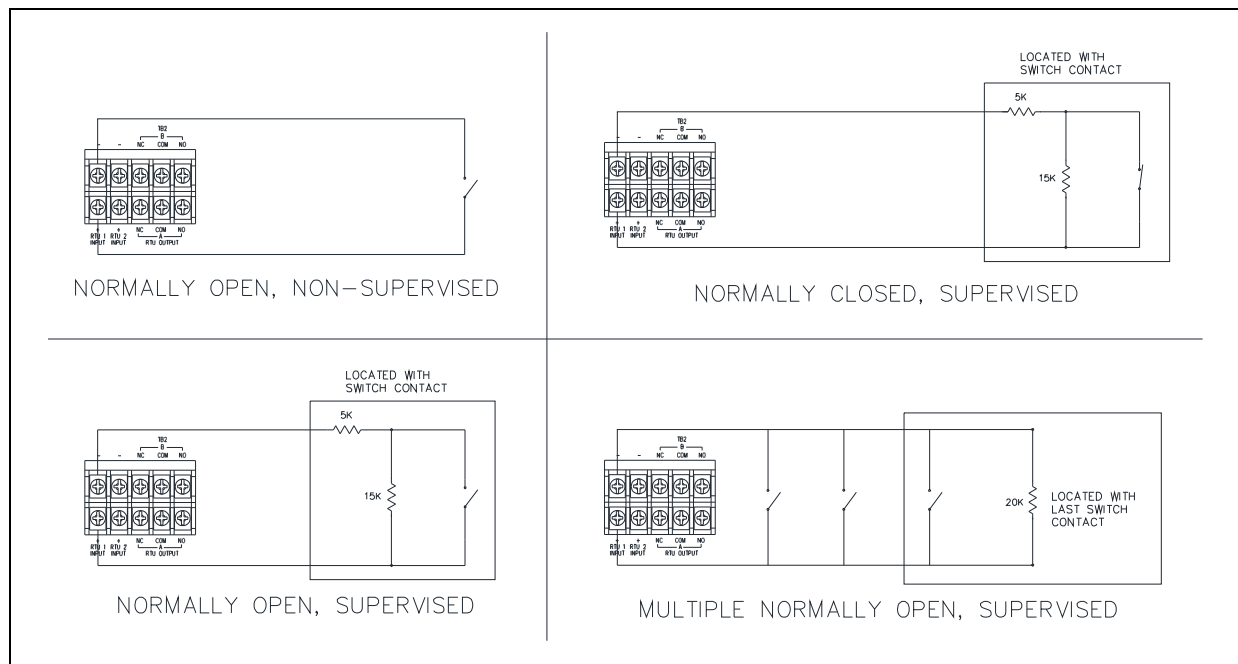

Figure 7. RTU Input Wiring Configurations for Cable Monitoring

**RTU Output**

Two form C contacts are provided to power a beacon (see Figure 8). Terminate the outputs at terminal block TB2 on the termination PCBA (see Figure 4). Remove jumpers JU1 and JU2 to configure the outputs for dry contact use.

**⚠ WARNING ⚠** —Line voltage is present at the NO contact until JU1 and JU2 are removed.

1. Pull the RTU output cable into the enclosure.
2. Install spade lugs on the wires.
3. Connect the RTU output wires to terminal block TB2 (see Table 5).
4. Torque the terminal block screws to 8–10 in·lb (0.90–1.13 N·m).

For beacon cable monitoring:

5. Install a 20-kilohm 10-watt resistor across the terminals of the beacon (see Figure 8).
6. Install jumpers at terminal block TB2 to enable cable monitoring (see Figure 8).

**NOTE:** Using an RTU input to monitor the beacon wiring makes it unavailable for other functions.

Table 5. RTU Output Contacts—TB2

Pin	Label	Description
TB2-5	NC A	Normally Closed Output A
TB2-6	NC B	Normally Closed Output B
TB2-7	COM A	Common Output A
TB2-8	COM B	Common Output B
TB2-9	NO A	Normally Open Output A
TB2-10	NO B	Normally Open Output B

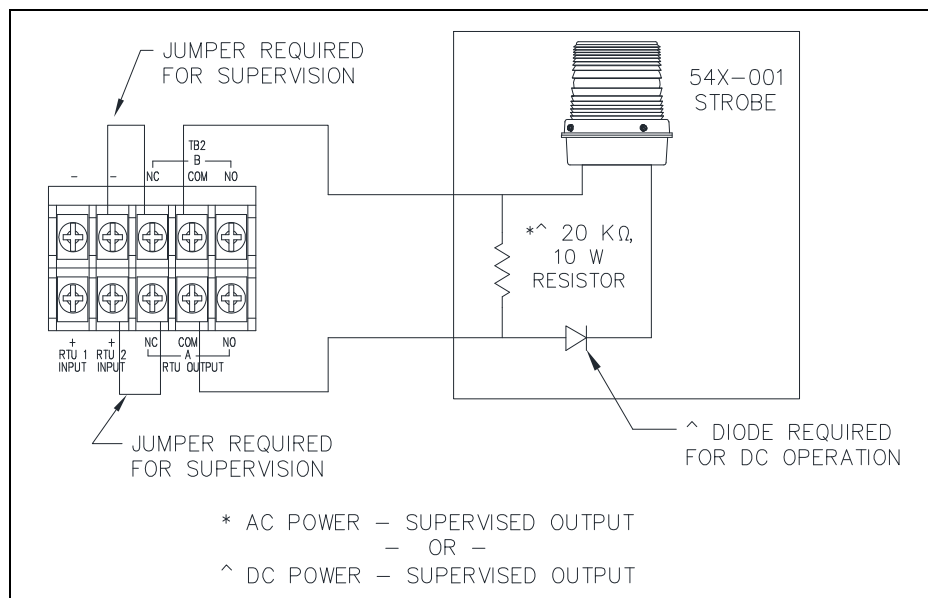

Figure 8. Supervised Output Wiring—TB2

## Power

The ac or optional dc power supply is on the termination PCBA. Connect the local ac or dc power source to terminal block TB3 (see [Figure 4](#), [Figure 5](#), and [Figure 6](#)):

1. Pull the cable from the power source into the enclosure.
2. Install spade lugs on the wires.
3. Connect the ac (see [Table 6](#)) or dc (see [Table 7](#)) power source conductors to terminal block TB3.
4. Torque the terminal block screws to 8–10 in·lb (0.90–1.13 N·m).

Table 6. AC Power—TB3

Pin	Label	Description
TB3-1	LINE	Positive
TB3-2	NEUTRAL	Negative
TB3-3	⊥	Earth ground

Table 7. DC Power—TB3

Pin	Label	Description
TB3-1	+	Positive
TB3-2	-	Negative
TB3-3		No Connection

## Main PCBA

### 600-Ohm Audio I/O with Control

SP2 stations have a 600-ohm audio input to broadcast line level audio over the page line. The station broadcasts the 600-ohm input audio stream upon closure of a normally open dry contact input control. SP2 stations also provide a 600-ohm audio output for sending page-line audio to a remote audio amplifier. A solid-state dry contact relay controls when the remote amplifier plays the audio.

1. Pull the cable for the 600-ohm audio I/O into the enclosure.
2. Install ferrules onto the wire ends.
3. Connect the 600-ohm audio wires to the pluggable terminal block for the 600-ohm audio I/O connection (see [Table 8](#) and [Figure 9](#)).
4. Connect the pluggable terminal block to terminal block receptacle TB1.

Table 8. 600-Ohm Audio I/O Interface Connections—TB1

Pin	Label	Description
TB1-1	IN CT1+	Input Control Positive
TB1-2	IN CT1-	Input Control Negative
TB1-3	IN AUD+	Input Audio Positive
TB1-4	IN AUD-	Input Audio Negative
TB1-5	OUT AUD+	Output Audio Positive
TB1-6	OUT AUD-	Output Audio Negative
TB1-7	OUT CT1+	Output Control Positive
TB1-8	OUT CT1-	Output Control Negative

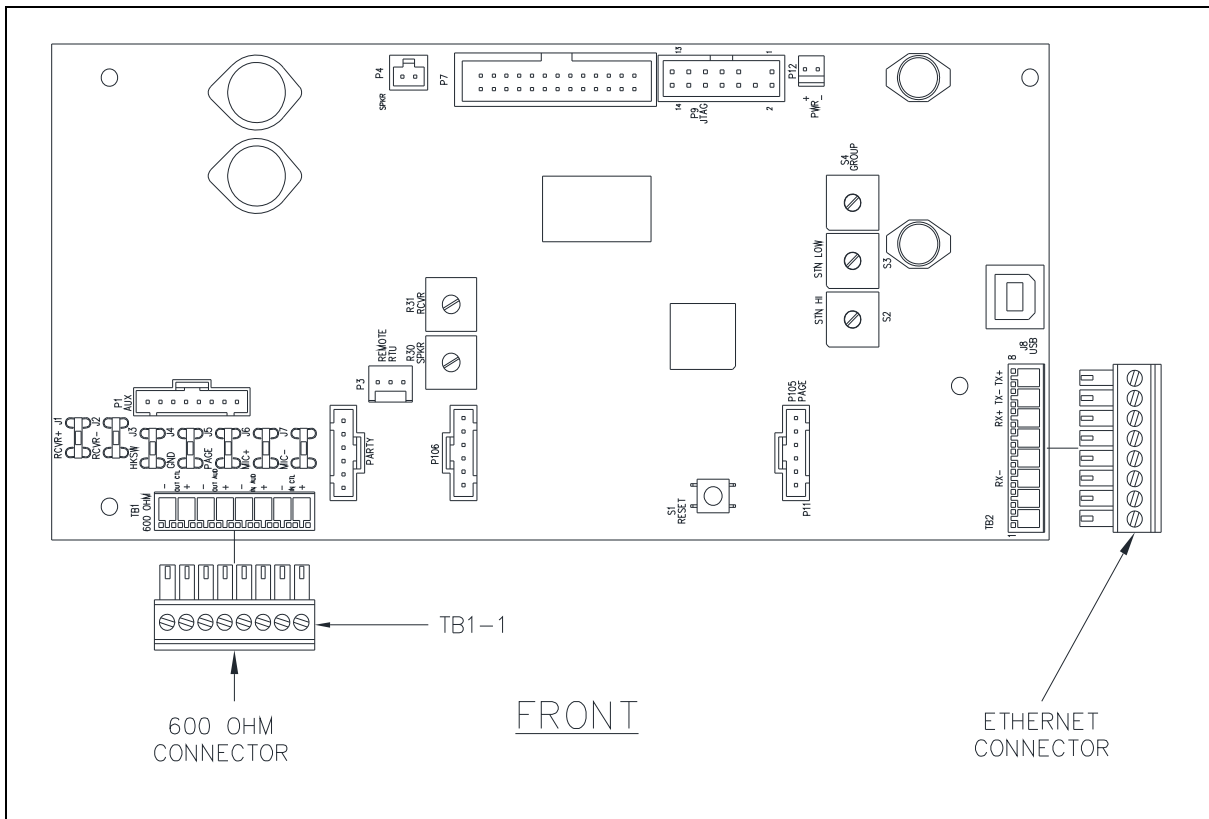

Figure 9. SP2 Main PCBA (Ethernet)

**Ethernet Termination**

1. Pull a dedicated category 5e or better Ethernet cable into the rear enclosure.  
Maximum Ethernet cable length is 100 m.
2. Install ferrules onto the wire ends.
3. Connect the Ethernet cable to the 8-position pluggable terminal block (see Figure 9)
4. Connect the pluggable terminal block to the main PCBA terminal block TB2 (see Figure 9).

**NOTE:** SP2 stations require shielded Ethernet cable or metallic conduit.

Table 9. Ethernet Connection—TB2

Pin	Label	Description
TB2-1		Unused
TB2-2		Unused
TB2-3	RX-	Data Receive -
TB2-4		Unused
TB2-5		Unused
TB2-6	RX+	Data Receive +
TB2-7	TX-	Data Transmit -
TB2-8	TX+	Data Transmit +

# Settings and Adjustments

## Open the Station

Complete the following steps to open the station:

1. Remove the four screws from the front panel and turn it to the left to expose the interior surfaces.
2. Keep the wiring and ribbon cables connected.
3. Mount the front panel to the rear enclosure using two of the screws just removed (see [Figure 10](#)).

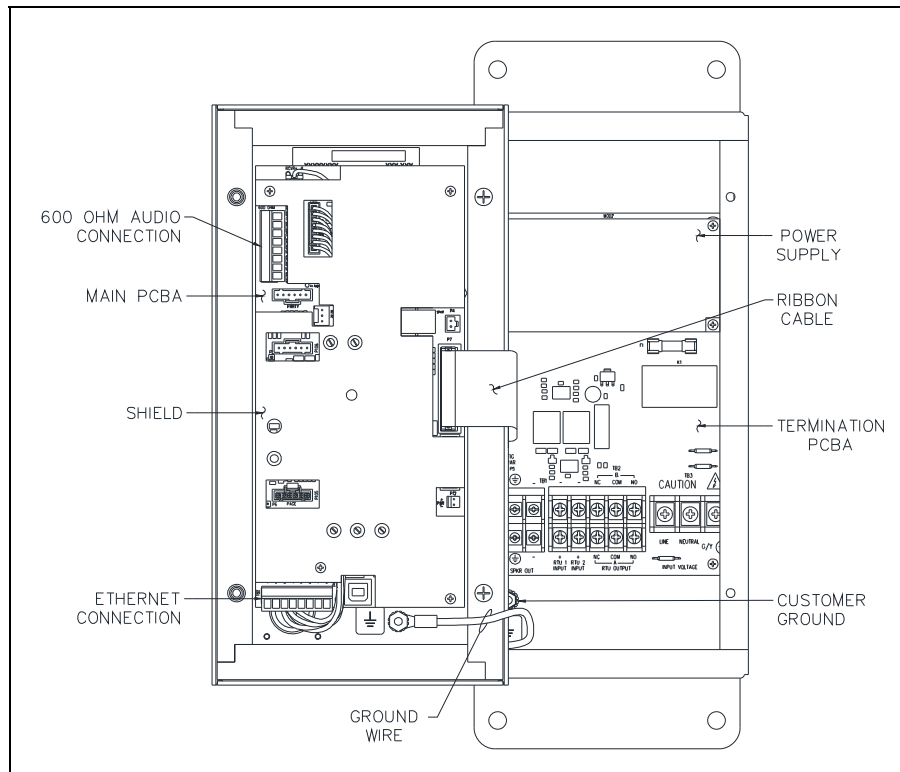

Figure 10. SP2 Station—Interior View

## Main PCBA Configuration

Refer to [Figure 11](#) for switch, jumper, and LED locations on the main PCBA.

### Write Protect (EEPROM) Jumper

**NOTE:** Do not adjust this jumper in the field.

### WDOG Enable (Watchdog) Jumper

Watchdog jumper, P11, enables a watchdog feature for software purposes. Do not adjust this jumper in the field. The default setting for this jumper is shorted.

### Boot Enable Jumper

Jumper P8—BOOT, is for development purposes only. Do not adjust this jumper in the field. The default setting for this jumper is open.

## Reset Switch

Reset switch, S1, reboots the station to its initial state. All configuration settings remain programmed.

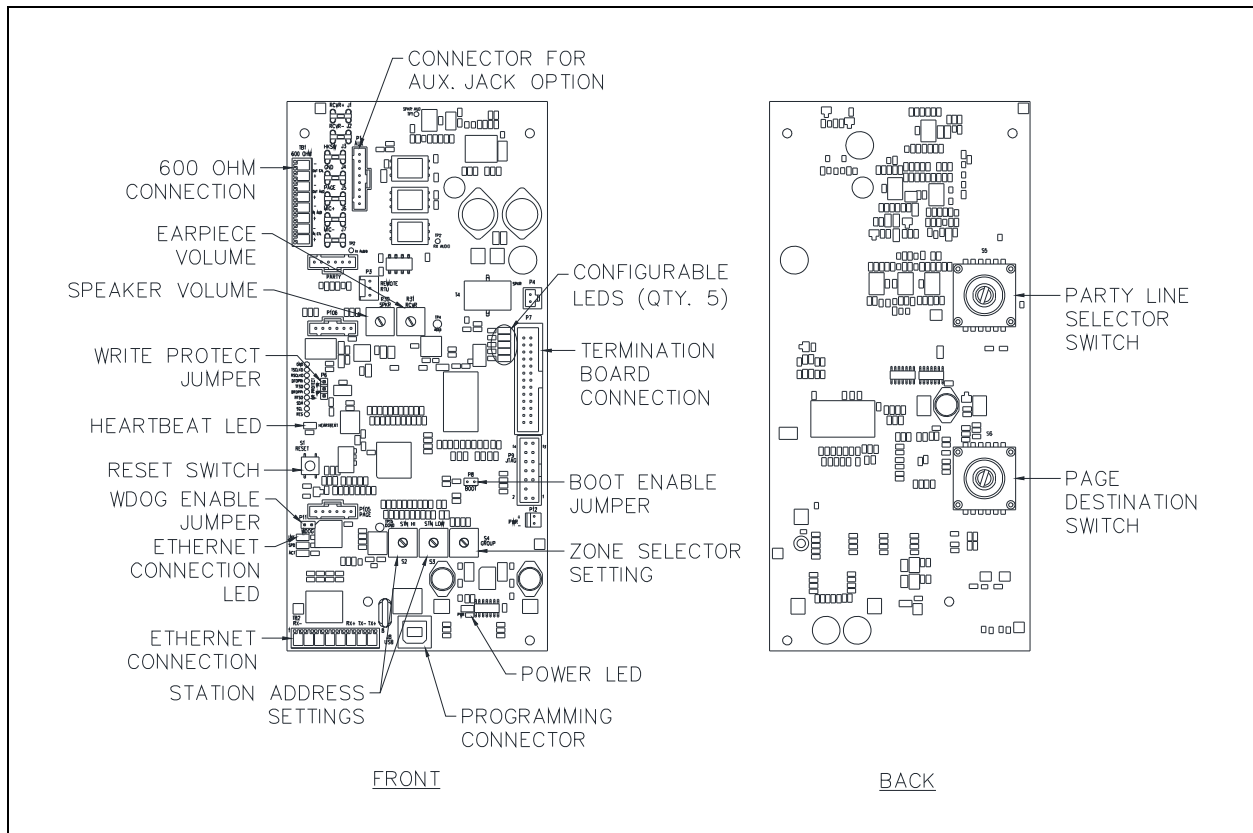

Figure 11. Main PCBA (Front and Rear Views)

## Speaker and 600-ohm Audio Output Volume

The speaker volume potentiometer, R36, adjusts the signal level to the speaker from the page line. When 600-ohm audio is also connected, R36 adjusts the volume for both. Use the CLI (Command Line Interface) to configure the output level when using 600-ohm audio without external speakers. The default setting is 4 watts from an 8-ohm speaker and 2 watts from a 16-ohm speaker.

**⚠ WARNING ⚠** —Maximum output power may exceed rated speaker wattage resulting in speaker damage.

To adjust the speaker or speaker and 600-ohm output volume:

1. Turn the speaker volume potentiometer, R36, fully counterclockwise.  
The speaker emits an audible test-tone.
2. Slowly turn R36 clockwise to obtain the desired output volume.  
The test-tone ceases three seconds after making no adjustments.

This setting is also configurable via USB or Ethernet connection using the CLI.

**NOTE:** Configuring this setting with the SP2 Console in a mutually provisioned system overrides this setting on the station. See the SP2 Configuration Guide, Pub. 42004-784 (see the [Reference Documentation](#) section).



## Receiver Volume

Use the receiver volume potentiometer, R37, to adjust the handset volume:

1. Remove the handset from the cradle.
2. Turn the RCVR potentiometer, R37, fully counterclockwise.  
The receiver emits an audible test-tone.
3. Slowly turn R37 clockwise to obtain the desired output volume.

The test-tone ceases three seconds after making no adjustments.

This setting is also configurable via USB or Ethernet connection using the CLI.

**NOTE:** Configuring this setting with the SP2 Console in a mutually provisioned system overrides this setting on the station. See the SP2 Configuration Guide, Pub. 42004-784 (see the [Reference Documentation](#) section).

## Group and Station Number Selector Switches

One *group-number* and two *station-number* hex-selector switches configure SP2 stations for *mutual provisioning* (see [Figure 11](#)). Each hex switch has a small arrow that indicates the current setting.

1. Adjust the position of the group-number selector switch to the desired group [0–F].
2. Adjust the two station-number switches to assign the station number [00–FF].

**NOTE:** Do NOT assign the same group/station number to more than one station.

Configure at least one SP2 station as a *master station* to utilize *mutual provisioning* in an SP2 system. Master stations must be assigned addresses [0.01], [0.02], or [0.03] using the selector switches. Master station(s) store the configuration of all SP2 stations on the network. Each SP2 station retrieves the mutual provisioning configuration from the master station as it powers up. See Pub. 42004-784, SP2 Configuration Guide, for detailed information on configuring SP2 stations and SP2 system mutual provisioning (see the [Reference Documentation](#) section).

## Main PCBA Indicators

### Power LED

The POWER LED illuminates when power is applied to the station, indicating the main board power supply is operational (see [Figure 11](#)).

### Heartbeat LED

The HEARTBEAT LED flashes when network communication is established to indicate the microprocessor is operational (see [Figure 11](#)).

### Ethernet Connection LEDs

The main PCBA contains three Ethernet connection LEDs; link (LNK), link speed (SPD), and activity (ACT). The LNK LED is blue, the SPD LED is green, and the ACT LED is yellow. The LNK and SPD LEDs indicate an active 100 Mbps Ethernet link when **off**. The activity LED, ACT, blinks yellow to indicate Ethernet data activity (see [Figure 11](#)).

## Five Configurable LEDs

Configure the five LEDs (see [Figure 11](#)) through firmware. Information for configuring these LED indicators is provided in the SP2 Configuration Guide, Pub. 42004-784 (see the [Reference Documentation](#) section).

## Front Cover Installation

After all adjustments are complete:

1. Place the front cover onto the rear enclosure.  
Do not to pinch any cables.
2. Secure the front cover using the four screws and washers provided.
3. Torque the screws to 50 in·lb (5.65 N·m).

## Programming

SP2 stations are factory configured to provide basic page/party functions upon power-up. Configure stations for custom configurations and/or larger system designs using the CLI or SP2 Console application. Refer to Publication 42004-784, SP2 Configuration Guide (see the [Reference Documentation](#) section).

## Operation

### Standard Handset Paging

Complete the following steps to make a page announcement from an SP2 handset station:

1. Lift the handset from the cradle.
2. *If requesting conversation:* rotate the five-position selector switch to select an unoccupied party line.
3. Press and hold the handset pressbar (not necessary when using the optional ALL-CALL button).
4. After hearing the short *preannouncement* tone (if configured), speak directly into the microphone to broadcast the page announcement.

**NOTE:** SP2 stations incorporate a noise-canceling microphone to reduce transmitted ambient noise. This requires the user to place the microphone as close as possible to their mouth.

5. *If requesting conversation:*
  1. Designate the party line selected in Step 2.
  2. Release the handset pressbar.
  3. Wait for the designated individual(s) to respond.

Full-duplex communication takes place on the party line without broadcasting over the system's speakers.

6. Replace the handset in the cradle.

## Party Line Communication

To respond to a page:

1. Turn the party-line selector switch on any SP2 station in the system to the requested party line.
2. Pick up the station handset.

Full-duplex communication takes place on the party line without broadcasting over the system's speakers.

**NOTE:** SP2 stations incorporate a noise-canceling microphone to reduce transmitted ambient noise. This requires the user to place the microphone as close as possible to their mouth.

3. Return the handset to the cradle following the party line conversation.

The system speakers do not broadcast party line conversations. Other individuals can join the conversation at any time by picking up a handset and rotating the party-line selector switch to the party line in use.

## All-Call Button Use

Use the ALL-CALL button to page an alternate destination that is programmed for the station (see Figure 12). The ALL-CALL option must be software configured for the SP2 station. To initiate a page using the ALL-CALL feature:

1. Lift the handset from the cradle.
2. *If requesting conversation:* rotate the party-line selector switch to an unoccupied party line.
3. Press and hold the ALL-CALL button.

The ALL-CALL button eliminates the need to press the handset or headset (if equipped) pressbar.

4. After hearing the short *preannouncement* tone (if configured), speak directly into the microphone to broadcast the page/announcement.

**NOTE:** SP2 stations incorporate a noise-canceling microphone to reduce transmitted ambient noise. This requires the user to place the microphone as close as possible to their mouth.

5. Release the ALL-CALL button and wait for a response on the party line (if requested).
6. Return the handset to the cradle when finished.

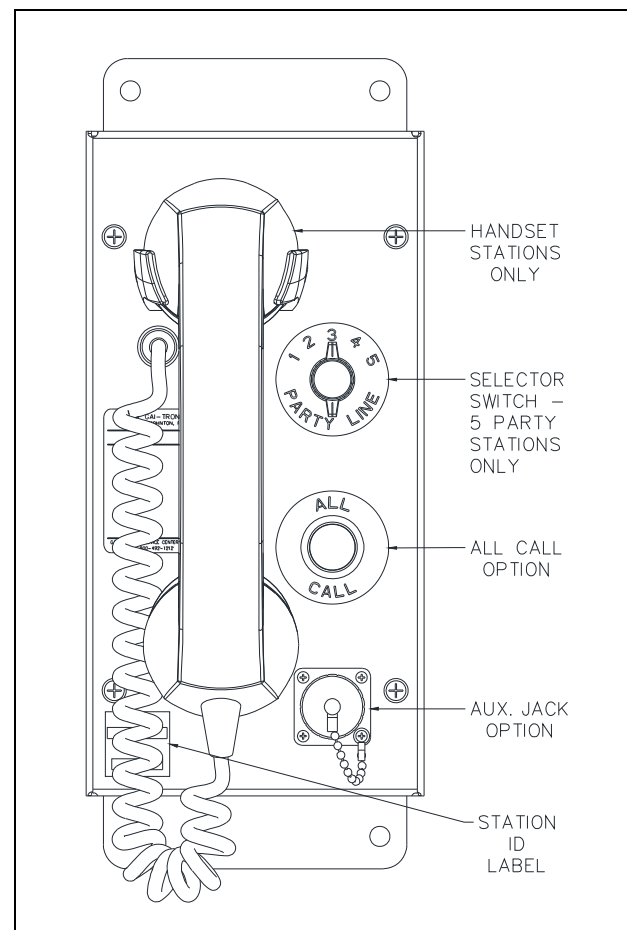

Figure 12. All-Call Button Location

## Alternate-Page Destination Switch Use

Use the ALT-PAGE selector switch to page one of five alternate destinations programmed for the station (see [Figure 13](#)). Alternate page destinations must be software configured for SP2 stations. To initiate a page using the ALT-PAGE selector switch:

1. Lift the handset from the cradle.
2. *If requesting conversation:* rotate the party-line selector switch to an unoccupied party line.
3. Select the desired page destination using the ALT-PAGE selector switch.
4. Press and hold the handset pressbar.
5. After hearing the short *preannouncement* tone (if configured), speak directly into the microphone to broadcast the page/announcement.

**NOTE:** SP2 stations incorporate a noise-canceling microphone to reduce transmitted ambient noise. This requires the user to place the microphone as close as possible to their mouth.

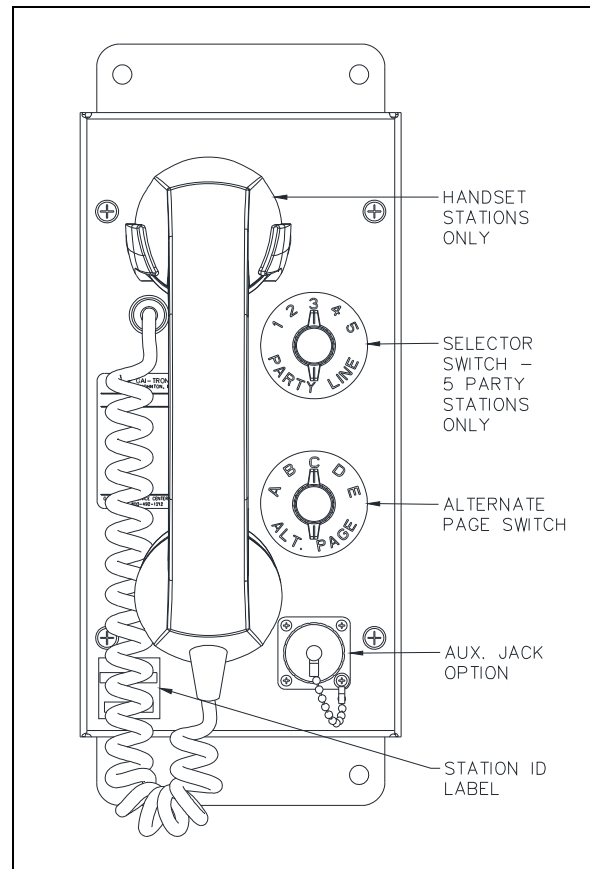

Figure 13. Alternate-Page Switch Location

6. Release the handset pressbar.
7. Return the handset to the cradle or wait for a response on the party line (if requested).

## Headset Use

Initiate a call with the optional headset feature as follows:

1. Attach the headset assembly to the auxiliary jack on the station (see [Figure 12](#) or [Figure 13](#)).
2. *If requesting conversation:* rotate the party-line selector switch (if equipped) to an unoccupied party line.
3. Rotate the ALT-PAGE selector switch (if available) or press the ALL-CALL button (if available) to select the desired optional destination for the page announcement.
4. Press and hold the headset pressbar (not necessary when using the optional ALL-CALL button).
5. After hearing the short *preannouncement* tone (if configured), speak directly into the microphone to broadcast the page/announcement.

**NOTE:** SP2 stations incorporate a noise-canceling microphone to reduce transmitted ambient noise. This requires the user to place the microphone as close as possible to their mouth.

6. Release the headset pressbar.
7. Wait for a response on the party line (if requested).

**NOTE:** For stations with an auxiliary jack, the Model 10401-201 Headset and Model 10416-103 Extension Cord allow the user to be hands-free and mobile while maintaining communication. Connecting the headset disables the handset microphone.

# Maintenance

## Troubleshooting

The following table provides aid to qualified service personnel for troubleshooting problems with an SP2 station.

Problem	Solution
station not functional	<ul style="list-style-type: none"> <li>• check wiring and cable terminations</li> <li>• check power supply voltage at TB3 on termination PCBA</li> <li>• Power LED on main PCBA illuminated</li> <li>• Heartbeat LED blinking once per second for normal operation</li> </ul>
network communication not functional	<ul style="list-style-type: none"> <li>• verify LNK LED on main PCBA is off</li> <li>• verify SPD LED on main PCBA is off</li> <li>• verify IP connection settings using telnet</li> <li>• ping station IP address from an admin PC</li> <li>• verify network switch settings for IGMP (Internet Group Management Protocol) snooping and multicast filtering</li> </ul>
handset receiver audio is too high/low	<ul style="list-style-type: none"> <li>• adjust the <u>receiver volume</u></li> <li>• check potentiometer R37 setting</li> <li>• check handset connections</li> <li>• check cable terminations between the termination and main PCBAs</li> <li>• check hookswitch operation</li> <li>• replace handset</li> </ul>
speaker volume is too high/low	<ul style="list-style-type: none"> <li>• adjust the <u>speaker and 600-ohm audio output volume</u></li> <li>• check potentiometer R36 setting</li> <li>• P2 and P3 termination PCBA jumper positions incorrect (see <u>Figure 5</u>)</li> <li>• check speaker wiring configuration on TB1</li> <li>• replace the speaker or driver</li> </ul>
RTU output is not functional	<ul style="list-style-type: none"> <li>• verify no monitored output faults exist</li> <li>• check fuse F1 on the termination PCBA</li> <li>• check connected device operation</li> </ul>
RTU input does not function	<ul style="list-style-type: none"> <li>• verify no monitored input faults exist</li> <li>• check <u>RTU Inputs</u> on TB2</li> <li>• check operation of connected device</li> </ul>

## Service and Spare Parts

Contact GAI-Tronics' regional service center if the equipment requires service or spare parts. An RA# (Return Authorization Number) will be issued if service is required. Ship equipment prepaid to GAI-Tronics with an RA# and a purchase order number. Repairs or a replacement are made in accordance with GAI-Tronics' warranty policy if the equipment is under warranty. Please include a written explanation of all defects to assist our technicians in their troubleshooting efforts. Call 800-492-1212 inside the USA or 610-777-1374 outside the USA for help with identifying the nearest regional service center.

Table 10. Replacement Parts

Part No.	Description
12508-002	Screw Kit (Qty. 32)

## Reference Documentation

GAI-Tronics' product documentation is located on the GAI-Tronics website at <https://www.gai-tronics.com>.

SP2 Configuration Guide ..... 42004-784

## Specifications

### Power

#### AC Input

Input voltage ..... 120/230 V ac (nominal), 50/60 Hz

Power factor @ nominal 120 V ac ..... 0.5

#### DC Input

Input voltage ..... 24 V dc +/-20%

Power Consumed (8-ohm load)	120 V AC	230 V AC	24 V DC
Idle	80 mA/6.6 VA	50 mA/12 VA	165 mA/4.0 W
4-watt output (default setting)	150 mA/18 VA	110 mA/25 VA	460 mA/11.0 W
30-watt output	550 mA/65 VA	350 mA/80 VA	1.95 A/46.8 W
Maximum Current Consumed (8-ohm load)	108 V AC	253 V AC	19.2 V DC
30-watt output	600 mA/65 VA	370 mA/77 VA	2.44 A/46.8 W

Current/Power requirements (+/-10%)

**Ethernet**

Cable .....	category 5e or better
Speed.....	100 Mbps
Maximum stations.....	4096
Maximum cable length .....	100 m

**RTU****Input Control**

Switch type.....	NO or NC dry contacts
End-of-line termination.....	20 k $\Omega$ , or 15 k $\Omega$ + 5.1 k $\Omega$
Cable resistance .....	100 $\Omega$ maximum loop resistance
Contact closure resistance.....	1 k $\Omega$ maximum
Open fault detection.....	>65 k $\Omega$
Short fault detection.....	<200 $\Omega$

**Output Control**

Maximum load current	
Output 1A (unfused).....	8.0 A
Output 1B (fused).....	1.6 A
Maximum in-rush current .....	15 A
Maximum voltage .....	250 V ac

**Audio****Handset**

Microphone.....	dynamic, noise-canceling
Receiver .....	dynamic, hearing aid compatible
Cord .....	retractile, 6-foot extended, PVC
Material.....	ABS

**Handset Amplifier**

Frequency response.....	250–3,000 Hz, +0/–3 dB ref. to 1 kHz
Distortion .....	<1.5% THD @ 1 kHz
Receiver level.....	200 mV nominal, adjustable 100–350 mV

**Headset Earpiece**

Level .....	100 mV nominal, adjustable 50–200 mV
-------------	--------------------------------------

**Speaker Amplifier**

## Maximum output:

8-ohm speaker.....	30 W into 8- $\Omega$ load with –6 dBfs data signal adjustable to 30 W; default: 4 W @ 8 $\Omega$
16-ohm speaker.....	15 W into 16- $\Omega$ load with –6 dBfs data signal adjustable to 15 W; default: 2 W @ 16 $\Omega$
Frequency response.....	250–3,000 Hz, +0/–3 dB ref. to 1 kHz
Distortion .....	<1% THD @ 1 kHz to 24 W <3% THD @ 1 kHz to 30 W

**70V/100V Speaker Output**

Maximum output.....	24 W
Nominal output voltage.....	70.7 V or 100 V

**600-ohm Audio Input**

Audio Level .....	1 V <sub>RMS</sub> maximum
Control type .....	NO dry contact
Control cable resistance .....	1 k $\Omega$ maximum loop resistance

**600-ohm Audio Output**

Frequency response.....	250–3,000 Hz, +0/–3 dB reference to 1 kHz
Distortion .....	<1% THD @ 1 kHz to 1 V <sub>RMS</sub> into 600 $\Omega$
Audio level.....	adjustable 100 mV <sub>RMS</sub> to 1 V <sub>RMS</sub> into 600 $\Omega$
Control type .....	NO solid-state relay, maximum on resistance: 35 $\Omega$
Control maximum load current.....	100 mA
Control maximum load voltage.....	24 V ac/dc

**Mechanical**

Construction/finish.....	16-gauge cold-rolled steel; safety orange polyurethane
Mounting.....	wall or column, four 0.312-inch (8 mm) mounting holes
Termination connections.....	screw-type barrier terminal blocks for power, speaker, and RTU
Phoenix connector pluggable terminal blocks for Ethernet and 600- $\Omega$ audio	

## Dimensions:

Enclosure .....	10.00 H $\times$ 5.00 W $\times$ 4.00 D in (254.0 $\times$ 127.0 $\times$ 101.6 mm)
Overall .....	12.50 H $\times$ 5.25 W $\times$ 7.34 D in (317.5 $\times$ 133.4 $\times$ 188.4 mm)

## External controls:

Multi-party stations.....	handset hookswitch and party line selector switch
Multi-page stations.....	page line selector switch

## Net weight:

standard amplifier: .....	6.0 lb
70V/100V amplifier: .....	7.0 lb
multi-party and options stations:.....	7.0 lb
70V/100V multi-party and option stations: .....	8.0 lb

## Shipping weight:

standard amplifier: .....	7.0 lb
70V/100V amplifier: .....	8.0 lb
multi-party and options stations:.....	8.0 lb
70V/100V multi-party and option stations: .....	9.0 lb

**Environmental**

Temperature range (operation and storage) .....	–22 °F to 140 °F (–30 °C to 60 °C)
Humidity .....	95% non-condensing

**Approvals**

NRTL certified for use in US and Canada.....	UL/CSA 60950 CE Mark
--	-------------------------



# Warranty

---

Equipment. GAI-Tronics warrants for a period of one (1) year from the date of shipment, that any GAI-Tronics equipment supplied hereunder shall be free of defects in material and workmanship, shall comply with the then-current product specifications and product literature, and if applicable, shall be fit for the purpose specified in the agreed upon quotation or proposal document. If (a) Seller's goods prove to be defective in workmanship and/or material under normal and proper usage, or unfit for the purpose specified and agreed upon, and (b) Buyer's claim is made within the warranty period set forth above, Buyer may return such goods to GAI-Tronics nearest depot repair facility, freight prepaid, at which time they will be repaired or replaced, at Seller's option, without charge to Buyer. Repair or replacement shall be Buyer's sole and exclusive remedy. The warranty period on any repaired or replacement equipment shall be the greater of the ninety (90) day repair warranty or one (1) year from the date the original equipment was shipped. In no event shall GAI-Tronics warranty obligations with respect to equipment exceed 100% of the total cost of the equipment supplied hereunder. Buyer may also be entitled to the manufacturer's warranty on any third-party goods supplied by GAI-Tronics hereunder. The applicability of any such third-party warranty will be determined by GAI-Tronics.

Services. Any services GAI-Tronics provides hereunder, whether directly or through subcontractors, shall be performed in accordance with the standard of care with which such services are normally provided in the industry. If the services fail to meet the applicable industry standard, GAI-Tronics will re-perform such services at no cost to buyer to correct said deficiency to Company's satisfaction provided any and all issues are identified prior to the demobilization of the Contractor's personnel from the work site. Re-performance of services shall be Buyer's sole and exclusive remedy, and in no event shall GAI-Tronics warranty obligations with respect to services exceed 100% of the total cost of the services provided hereunder.

Warranty Periods. Every claim by Buyer alleging a defect in the goods and/or services provided hereunder shall be deemed waived unless such claim is made in writing within the applicable warranty periods as set forth above. Provided, however, that if the defect complained of is latent and not discoverable within the above warranty periods, every claim arising on account of such latent defect shall be deemed waived unless it is made in writing within a reasonable time after such latent defect is or should have been discovered by Buyer.

Limitations / Exclusions. The warranties herein shall not apply to, and GAI-Tronics shall not be responsible for, any damage to the goods or failure of the services supplied hereunder, to the extent caused by Buyer's neglect, failure to follow operational and maintenance procedures provided with the equipment, or the use of technicians not specifically authorized by GAI-Tronics to maintain or service the equipment. **THE WARRANTIES AND REMEDIES CONTAINED HEREIN ARE IN LIEU OF AND EXCLUDE ALL OTHER WARRANTIES AND REMEDIES, WHETHER EXPRESS OR IMPLIED BY OPERATION OF LAW OR OTHERWISE, INCLUDING ANY WARRANTIES OF MERCHANTABILITY OR FITNESS FOR A PARTICULAR PURPOSE.**

## Return Policy

---

If the equipment requires service, contact your Regional Service Center for a return authorization number (RA#). Equipment should be shipped prepaid to GAI-Tronics with a return authorization number and a purchase order number. If the equipment is under warranty, repairs or a replacement will be made in accordance with the warranty policy set forth above. Please include a written explanation of all defects to assist our technicians in their troubleshooting efforts.

Call 800-492-1212 (inside the USA) or 610-777-1374 (outside the USA) for help identifying the Regional Service Center closest to you.